

(1) WBT 4 IR

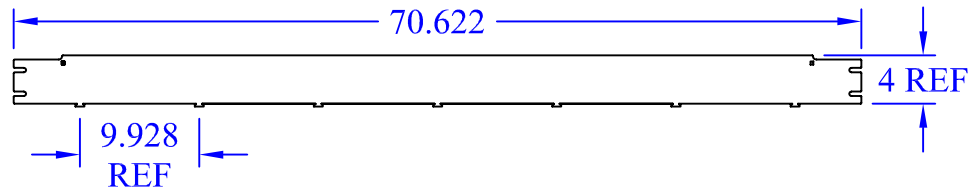

(1) WBT-90-4x36 OR

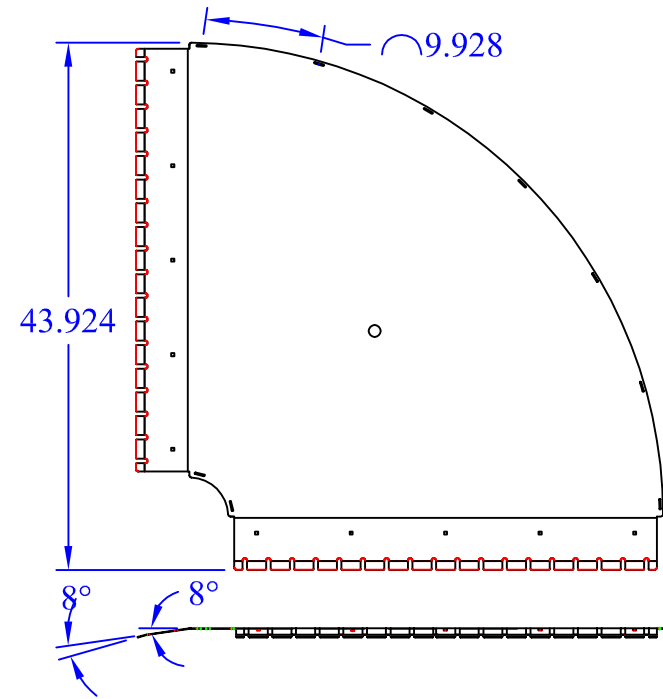

(1) WBT-90-Xx36 Base

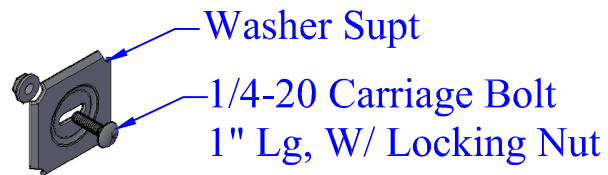

(8) Washer Supt



This drawing in design and detail is the property of WBT, LLC. and must not be used except in connection with our work. All rights of design or invention are reserved.

PART # OR NAME		DRAWN BY	
WBT-90-4x36 XX		RJM	
SIZE	DATE	SCALE	SHEET
A	2/17/16	VARIES	1 OF 1
			REV
			N/A