

(1) WBT 2 IR

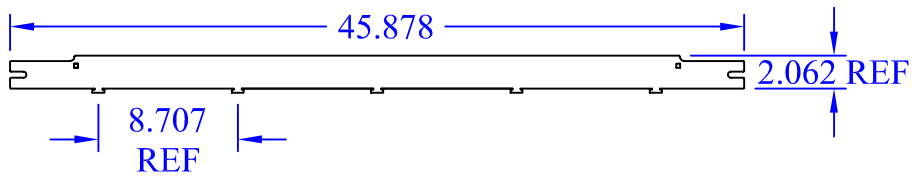

(1) WBT-90-2x20 OR

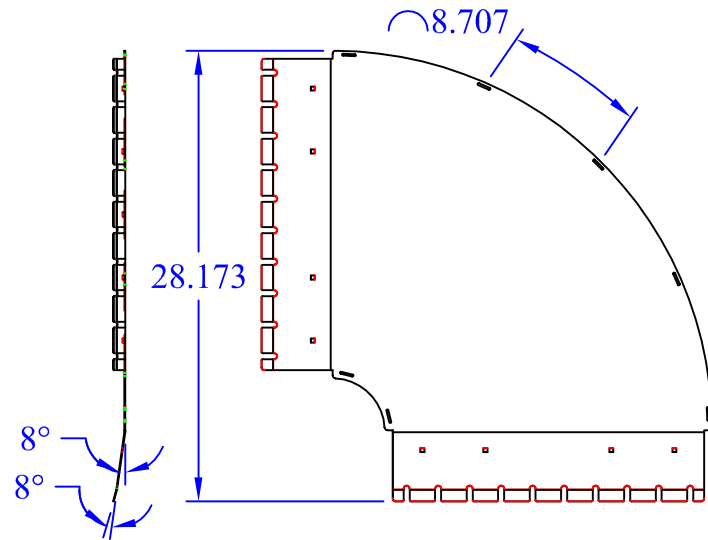

(1) WBT-90-Xx20 Base

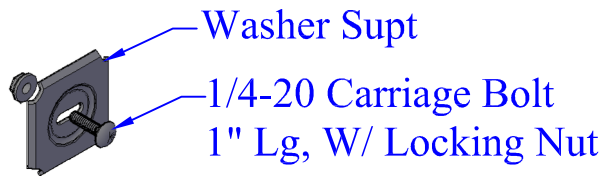

(6) Washer Supt



This drawing in design and detail is the property of WBT, LLC. and must not be used except in connection with our work. All rights of design or invention are reserved.

PART # OR NAME		DRAWN BY	
WBT-90-2x20 XX		RJM	
SIZE	DATE	SCALE	SHEET
A	10/9/15	VARIES	1 OF 1
			REV
			N/A